

**TORMEK®****SVD-005**

**NOW** Fits  
turning cutters  
with 4–8 mm  
holes!

**EN** Upgrade kit for SVD-180/185

**SV** Kompletteringssats för SVD-180/185

**DE** Komplettierungssatz für SVD-180/185

**FR** Kit complémentaire pour SVD-180/185

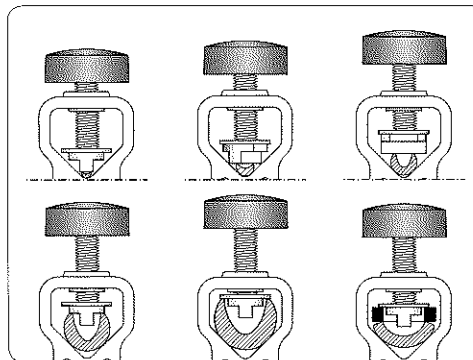
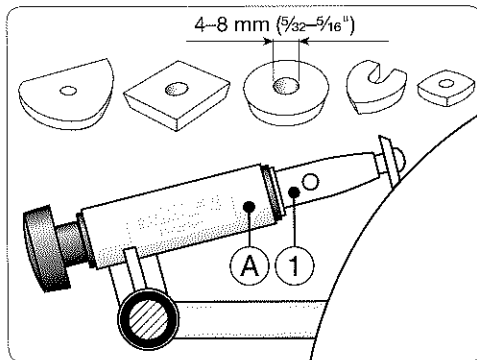

**EN** With the shaft (1) mounted in the sleeve (A) of your SVD-180 jig you have the perfect jig for turning cutters.

**SV** Med axeln (1) monterad i styrhylsan (A) från jiggen SVD-180 får du en perfekt jig för svarvskärstål.

**DE** Mit der in die Führungshülse (A) Ihrer Vorrichtung SVD-180 montierten Welle (1) erhalten Sie eine perfekte Vorrichtung für auswechselbare Klingen.

**FR** Avec l'arbre (1) monté dans le guide (A) du dispositif SVD-180, vous aurez un outil parfait pour les lames de racloirs.

**EN** A specially designed mounting disc and a removable washer cope with all types and sizes of tools.

**SV** En specialkonstruerad monteringsdyna och en bricka klarar alla verktygstyper och storlekar.

**DE** Eine Spezialdruckplatte und eine Scheibe halten alle Werkzeugtypen und Größen.

**FR** Le coussinet de conception spécifique et la rondelle permettent le montage d'outils de tous types et dimensions.

## Contents

- 1 Shaft with locking ring and mounting screw
- 2 Mounting disc
- 3 Washer
- 4 Knob screw (new, longer)
- 5 Allen key
- 6 Instructions SVD-185

## Innehåll

- 1 Axel med låsring och monteringskrav
- 2 Monteringsdyna
- 3 Bricka
- 4 Rattskruv (ny, längre)
- 5 Sexkantnyckel
- 6 Instruktion SVD-185

## Inhalt

- 1 Welle mit Schliessring und Befestigungsschraube
- 2 Druckplatte
- 3 Scheibe
- 4 Feststellschraube (neu, länger)
- 5 Sechskantschlüssel
- 6 Anleitung SVD-185

## Contenu

- 1 Arbre avec bague d'arrêt et vis de montage
- 2 Coussinet
- 3 Rondelle
- 4 Vis à bouton (nouvelle, plus longue)
- 5 Clé hexagonale
- 6 Instruction SVD-185

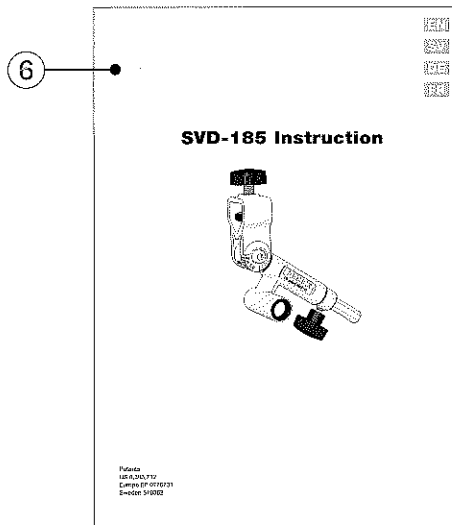
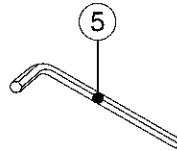
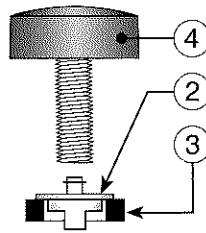
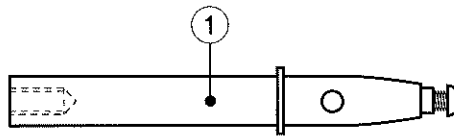

Patents  
US 6,393,712  
Europe EP 0776731  
Sweden 510362

8270-1404

# TORMEK

## R-51



**Kompletteringssett for SVD-180.**  
For automatisk oppriktning av verktøyet.



**Update Kit for SVD-180.**  
For automatic tool alignment.



**Nachrüstsetz für SVD-180.**  
Zur automatischen Positionierung des Werkzeuges.



**Jeu complémentaire pour SVD-180.**  
Pour un alignement automatique de l'outil.

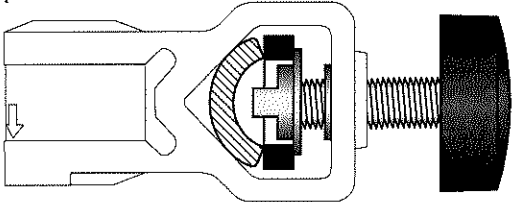

**Monteringsinstruksjon.**



**Montageanweisung.**

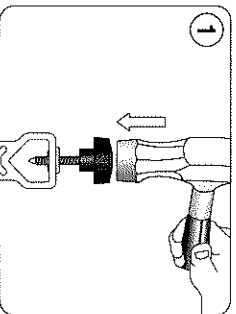

**Mounting instruction.**



**Instructions de montage.**

